



**Stego, Inc.**

95 Chastain Road NW

Suite 200

Kennesaw, GA 30144, USA

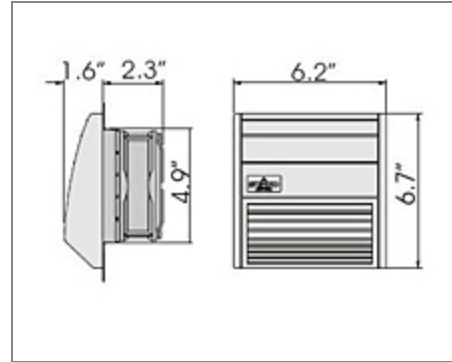
**Toll-Free:** (888) 783-4611 • **Phone:** (770) 984-0858

**Email:** [info@stegousa.com](mailto:info@stegousa.com) • **Website:** [www.stego-usa.com](http://www.stego-usa.com)
**Part # 01801.0-06, Standard Filter Fan**

[Specifications](#) | [Technical Data](#)
**Specifications**

<b>Free Blowing Air Flow</b>	32 cfm (55 m <sup>3</sup> /h)
<b>Voltage</b>	48 VDC
<b>Environmental Ratings<sup>1</sup></b>	UL Type 1 / IP55
<b>Agency Approvals</b>	UL

**Technical Data**

<b>Version</b>	Standard
<b>Air Flow with Exit Filter</b>	25 cfm (42 m <sup>3</sup> /h)
<b>Average Noise Level at 3 ft (DIN EN ISO 4871)</b>	40 dB (A)
<b>Grill Size</b>	6 x 6 inch
<b>Enclosure Cut-Out</b>	4.9 x 4.9 inches (125 x 125 + 0.4 mm)
<b>Mounting Depth</b>	2.3 inches (58 mm)
<b>Weight</b>	2.2 lb (1 kg)

<b>Filter Fan Housing</b>	Plastic, UL 94V-0, light gray
<b>Filter Fan Hood</b>	Plastic, UL 94V-0, light gray, weather proof and UV light resistant according to UL 746C (f1)
<b>Mounting Frame</b>	With double sided industrial adhesive band for affixing to the outside of enclosure. Certain operating circumstances may make the additional use of screws necessary.
<b>Filter Mat</b>	Medium grade 350 g/m <sup>2</sup> , filtering degree 94 % for particle Ø < 10 µm, G4 (EN 779)
<b>Filter Material</b>	Synthetic fiber with progressive construction, temperature resistant to 212 °F, self-extinguishing class F1. Moisture resistant to 100% RH. Can be cleaned by washing or vacuuming for reuse. Replacement filter mats available on request.
<b>Axial Fan, Ball Bearing</b>	Aluminum frame, plastic impeller UL 94V-0, Operational life min. 50,000 h at 77 °F (RH 65 %). Operating temperature -49 °F to 158 °F 2 lead wires 4" long with pressure clamps, type AWG 14 max.
<b>Connection</b>	2 wires w/ cage clamps, AWG 14 (2.5 mm <sup>2</sup> ), length 4" (100 mm)
<b>Operating Temperature</b>	14 to 158 °F (-10 to 70 °C)
<b>Storage Temperature</b>	-40 to 158 °F (-40 to 70 °C)
<b>Protection Type<sup>2</sup></b>	IP55 (according to VDE)
<b>Protection Class</b>	I (grounded)

<sup>1</sup> Using fine filter mat type F5 increases the protection type to UL Type 12 but reduces the air volume

<sup>2</sup> Using fine filter mat type F5 increases the protection type to UL Type 12 but reduces the air volume